



DSA2062

INSTALLATION/OWNER'S MANUAL

DVD Multimedia Receiver with 6.2" Touch Screen Display



Safety Notes:

The DVD video display of the in-dash unit will not operate while the vehicle is moving. This is a safety feature to prevent driver distraction. In-dash DVD video functions will only operate when vehicle is in Park and the parking brake is engaged. It is illegal in most states for the driver to view video while the vehicle is in motion.

Copyright Notes

This product incorporates copyright protection technology that is protected by method claims of certain U.S. patents and other intellectual property rights owned by Macrovision Corporation and other rights owners. Use of this copyright protection technology must be authorized by Macrovision Corporation, and is intended for home and other limited viewing uses only unless otherwise authorized by Macrovision Corporation. Reverse engineering or disassembly is prohibited.

Manufactured under license from Dolby Laboratories.

Dolby and the double-D symbol are registered trademarks of Dolby Laboratories.

DVD logo is a trademark of DVD Format/Licensing Corporation registered in the U.S., Japan and other countries.

microSD logo is a trademark of SD-3C, LLC.

Other trademarks and trade names are those of their respective owners.



Table of Contents

	Page
Warning Statement	3
Safety Information/Precautions	4
Preparation/Mounting	5
Wiring Diagram	6
Control Locations	7
Remote Preparation	8
General Operation	9-10
AM/FM Tuner Operation	11-12
CD Operation	13-14
MP3/WMA/JPG Operation	15-21
DVD Operation	22-26
Auxiliary Inputs/Rear Camera Operation.....	27
Warranty	27
Specifications	29
Troubleshooting	30



DSA2062 PREPARATION

⚠ WARNING ⚠

Upon installation of this Monitor/DVD player (“unit”) into a vehicle, the driver of the vehicle must not operate this unit by watching videos or playing video games while driving. Failure to follow this instruction could lead to driver distraction which could result in serious injury or death to the vehicle’s occupants or persons outside the vehicle and/or property damage.

Several states prohibit the installation of monitors/DVD players if the screen is visible from the driver’s seat. If you reside in a jurisdiction which has enacted such a law, this unit must not be installed so that the screen is visible from the driver’s seat. When installing this unit in the front console/dashboard, the unit must be positioned so that it is facing the front passenger seat only. Failure to follow this instruction could lead to driver distraction which could result in serious injury or death to the vehicle’s occupants or persons outside the vehicle and/or property damage.

This unit is designed so that it may be operated only when the vehicle is in “Park” and the parking brake is fully engaged. To this end, this unit includes a parking brake lock-out feature which prohibits the unit from operating if the vehicle is not in “Park” and/or the parking brake is not fully engaged. When installing this unit, the installer must connect the parking brake detect wire (“Pink Lead”) to the parking brake mechanism in order to make the parking brake lock-out feature operable. DO NOT simply ground the parking brake detect wire to a metal portion of the vehicle. Failure to properly install the parking brake lock-out feature could lead to driver distraction which could result in serious injury or death to the driver’s occupants or persons outside the vehicle and/or property damage.

Once the parking brake lock-out feature is installed, the owner/user must not attempt to disrupt/neutralize the parking brake lock-out feature by (a) partially engaging the parking brake and/or (b) purchasing/using any device or unit designed to send necessary brake signals to the unit. Failure to follow these instructions could lead to driver distraction which could result in serious injury or death to the driver’s occupants or persons outside the vehicle and/or property damage.

When operating this unit, keep the unit’s volume level low enough so that the vehicle’s occupants can hear traffic-related sounds such as police and emergency vehicles. Failure to follow this instruction could lead to driver distraction which could result in serious injury or death to the vehicle’s occupants or persons outside the vehicle and/or property damage.



Safety Information

Please read all instructions carefully before attempting to install or operate.

Due to its technical nature, it is highly recommended that your DUAL DSA2062 is installed by a professional installer or an authorized dealer. This product is only for use in vehicles with 12VDC negative ground only.

To prevent damage or injury:

- Make sure to ground the unit securely to the vehicle chassis ground.
- Do not remove the top or bottom covers of the unit.
- Do not install the unit in a spot exposed to direct sunlight or excessive heat or the possibility of water splashing.
- Do not subject the unit to excessive shock.
- When replacing a fuse, only use a new one with the prescribed rating. Using a fuse with the wrong rating may cause the unit to malfunction.
- To prevent short circuits when replacing a fuse, disconnect the wiring harness first.
- Use only the provided hardware and wire harness.
- You cannot view video while the vehicle is moving. Find a safe place to park and engage the parking brake.
- If you experience problems during installation, consult your nearest DUAL dealer.
- If the unit malfunctions, reset the unit as described on page 9 first. If the problem still persists, consult your nearest DUAL dealer or call tech assistance @ 1-866-382-5476.
- To clean the monitor, wipe only with a dry silicone cloth or soft cloth. Do not use a stiff cloth, or volatile solvents such as paint thinner and alcohol. They can scratch the surface of the panel and/or remove the printing.
- When the temperature of the unit falls (as in winter), the liquid crystal inside the screen will become darker than usual. Normal brightness will return after using the monitor for a while.
- When extending the ignition, battery or ground cables, make sure to use automotive-grade cables or other cables with an area of 0.75mm (AWG 18) or more to prevent voltage drops.
- Do not touch the liquid crystal fluid if the LCD is damaged or broken. The liquid crystal fluid may be hazardous to your health or fatal. If the liquid crystal fluid from the LCD contacts your body or clothing, wash it off with soap immediately.

FCC Compliance

This device complies with Part 15 of the FCC Rules. Operation is subject to the following two conditions:

- (1) this device may not cause harmful interference, and
- (2) this device must accept any interference received, including interference that may cause undesired operation.

Warning: Changes or modifications to this unit not expressly approved by the party responsible for compliance could void the user's authority to operate the equipment.

Note: This equipment has been tested and found to comply with the limits for a Class B digital device, pursuant to Part 15 of the FCC Rules. These limits are designed to provide reasonable protection against harmful interference in a residential installation. This equipment generates, uses and can radiate radio frequency energy and, if not installed and used in accordance with the instructions, may cause harmful interference to radio communications. However, there is no guarantee that interference will not occur in a particular installation. If this equipment does cause harmful interference to radio or television reception, which can be determined by turning the equipment off and on, the user is encouraged to try to correct the interference by one or more of the following measures:

- Reorient or relocate the receiving antenna.
- Increase the separation between the equipment and receiver.
- Connect the equipment into an outlet on a circuit different from that to which the receiver is connected.
- Consult the dealer or an experienced radio/TV technician for help.



DSA2062 INSTALLATION

Preparation

Before You Start

- Disconnect negative battery terminal. Consult a qualified technician for instructions.
- Avoid installing the unit where it would be subject to high temperatures, such as from direct sunlight, or where it would be subject to dust, dirt or excessive vibration.

Getting Started

- Insert the supplied keys into the slots as shown, and slide the unit out of the mounting sleeve.
- Install mounting sleeve into opening, bending tabs to secure.
- Connect wiring harness as shown on page 6. Consult a qualified technician if you are unsure.
- Certain vehicles may require an installation kit and/or wiring harness adapter (sold separately).
- Reconnect negative battery terminal, and test for correct operation.
- Snap trim ring into place (if required).
- Slide unit into mounting sleeve to secure.

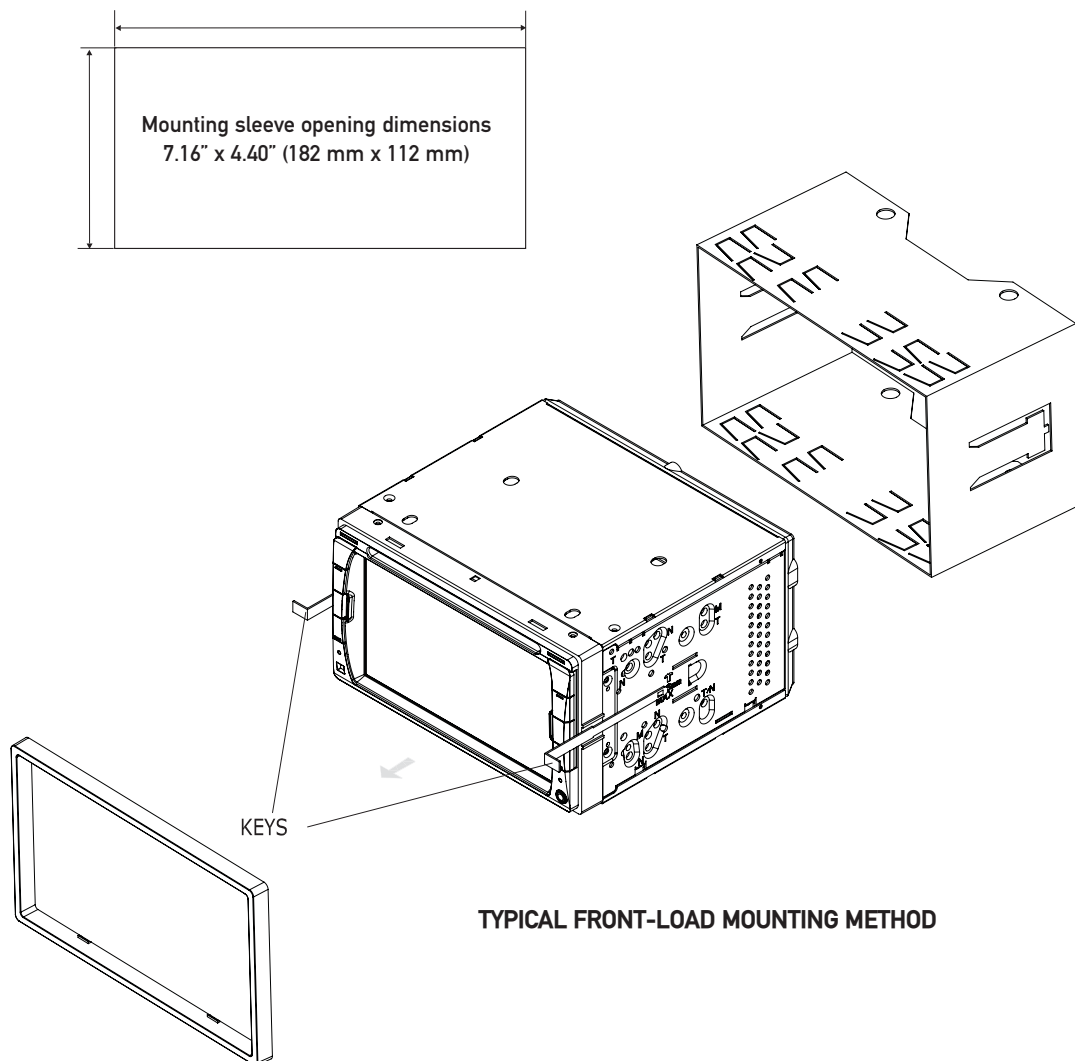

Wiring Diagram - Inputs/Outputs

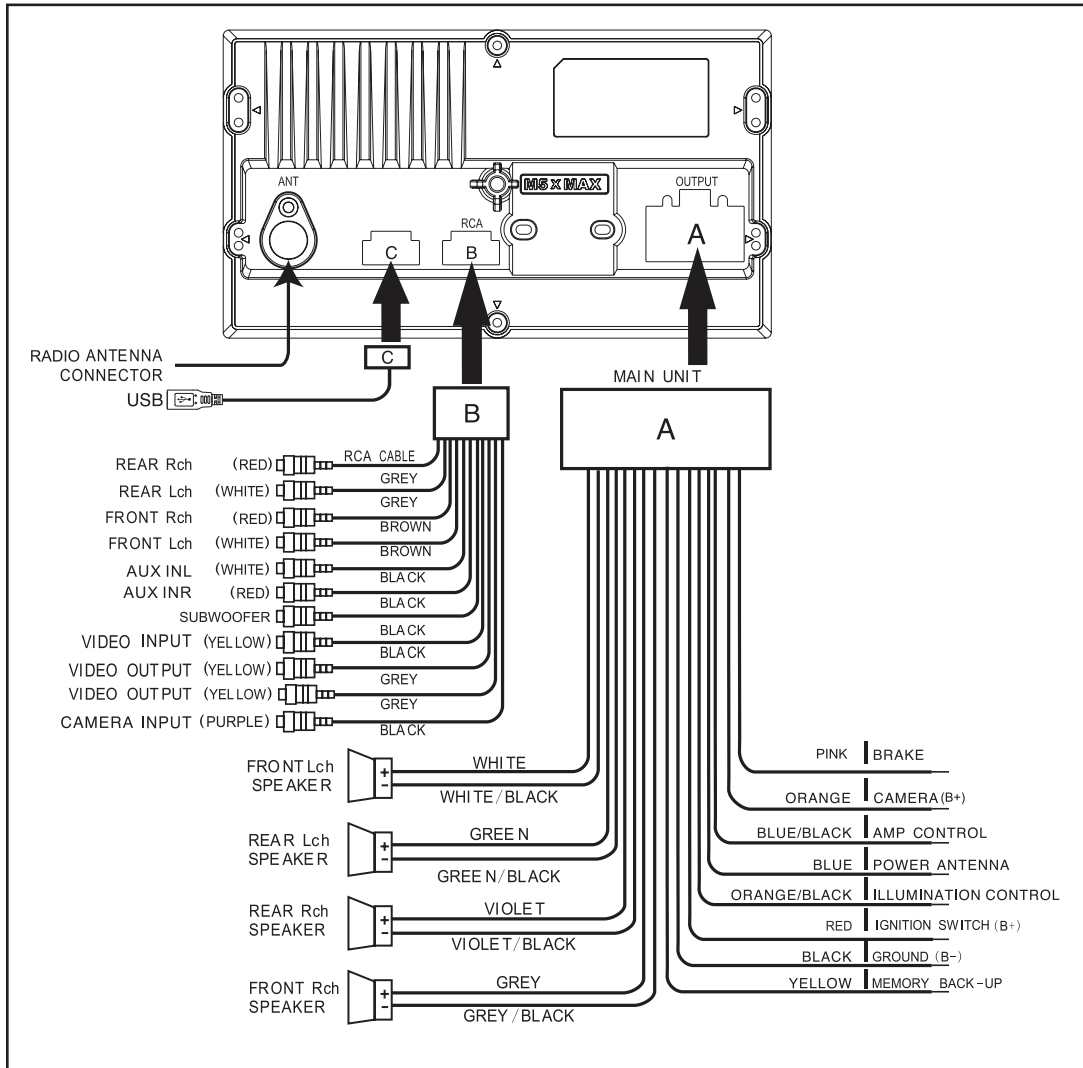

Wiring Notes:

Subwoofer output

The Subwoofer preamp audio output (black jacket with green RCA) is active in all audio modes.

Rear camera input

A rear view camera (not included) can be used with the Camera input. Refer to page 27 for details.

Note:

When replacing a fuse, make sure to use the correct type and amperage. Using an incorrect fuse could damage the unit. The DSA2062 uses (1) 15 amp ATC mini style fuse located on the back of the unit.



DSA2062 OPERATION

Control Locations



- | | |
|---------------------|------------------------|
| ① microSD Card Slot | ⑥ Auxiliary A/V Input |
| ② Power / Mode | ⑦ Reset |
| ③ Mute / Standby | ⑧ Tuner Mode Selection |
| ④ Volume Up | ⑨ DVD Mode Selection |
| ⑤ | ⑩ EQ / Loudness |
| | ⑪ Eject |

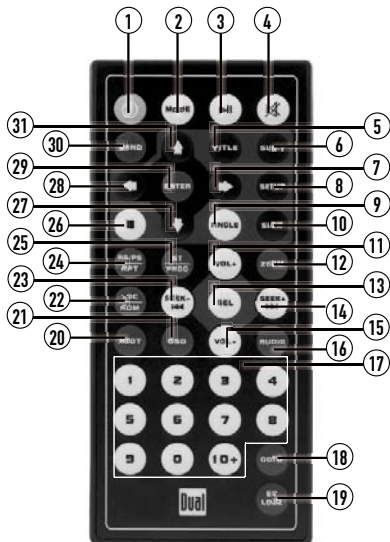

- | | | |
|-------------------|-------------------|---------------------|
| ① Power | ⑬ Select | ⑯ Audio |
| ② Mode | ⑭ Tune / Track Up | ⑰ Number Keys |
| ③ Play / Pause | ⑮ Volume Down | ⑱ GOTO |
| ④ Mute | | ⑲ EQ / Loudness |
| ⑤ Title | | ⑳ Root |
| ⑥ Subtitle | | ㉑ OSD |
| ⑦ Arrow Right | | ㉒ Local / Random |
| ⑧ Setup | | ㉓ Tune / Track Down |
| ⑨ Angle | | ㉔ AS/PS / Repeat |
| ⑩ Slow | | ㉕ ST / Program |
| ⑪ Volume Up | | ㉖ Stop |
| ⑫ Zoom | | ㉗ Arrow Down |
| ⑬ Select | | ㉘ Arrow Left |
| ⑭ Tune / Track Up | | ㉙ Enter |
| ⑮ Volume Down | | ㉚ Band |
| | | ㉛ Arrow Up |

Remote Control Preparation

Remove battery insulation tape .



To insert or replace the battery, remove the battery holder.

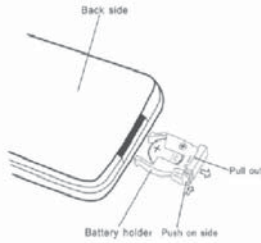

Remove the battery from the battery holder.

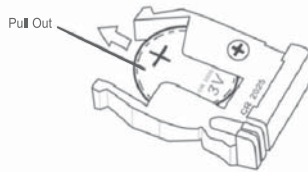

Install the new battery. Make sure to keep the (+) side up.

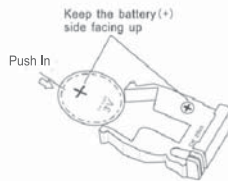

Insert the battery holder .

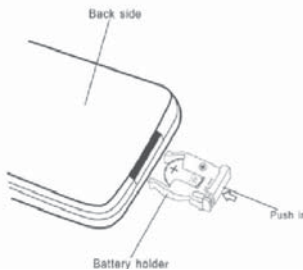



Notes:

- The remote control uses one 3 volt Lithium CR2025 battery. Remove the battery if the remote will not be used for a month or longer.
- Remove and dispose of battery properly.
- Do not store battery with metallic objects or materials.



General Operation

Power On/Off	Momentarily press  to turn the unit on. Press and hold  for 2 seconds to turn the unit off.
Volume	Press VOL ▲ or VOL ▼ to increase or decrease the volume level (0-39).
Volume Memory	If the volume level is <21 when the unit is turned off, it will be retained in memory the next time the unit is turned on. If the volume level is >20 when the unit is turned off, the volume level will automatically default to 20 the next time the unit is turned on.
Mute	Momentarily press MUTE to silence the audio;  will appear on the OSD (On Screen Display). Momentarily press MUTE again to return to the previously selected volume. Pressing VOL ▲ or VOL ▼ while the volume is muted will also cancel the mute function.
Standby	Press and hold MUTE to put the unit in standby mode. Momentarily press MUTE to return to the previous mode of operation, or press DVD or TUNER to access those modes directly.
Mode	Press MODE to step through all available input modes: Tuner, Disc (which includes DVD and CD playback), SD, USB, AV1 and AV2. Modes of operation are indicated on the OSD On Screen Display. Optional USB flash drive and microSD card must be connected/inserted to appear in the mode selection string.
Reset	To resolve abnormal operation or if the unit is inoperable, use the tip of a pen to press the RESET button located in the top right corner. The unit will reset the main processor to the default settings.
3.5mm A/V Input	Connect external audio/video devices to the 3.5mm auxiliary A/V input on the front panel.
Menu	From any mode of operation, press the arrow in the top right corner to access the Main Menu screen.



- From the Main Menu screen:
- View/select any operational mode by touching the corresponding icon.
 - Enter standby mode by pressing **STANDBY**.
 - Select **SETUP** to enter the Setup menu.



General Operation

Setup Menu

From the Main Menu screen, press **SETUP** in the bottom left corner to access the Setup menu. Select one of the seven icons across the top (General, Time, Language, Audio, Video, Tuner and Calibration) to access the sub-menu for that category. Use the up and down arrow keys on the right to scroll up and down through the available sub-menu options.

General

- **Beep** - Select **Off** or **On** to disable or enable the audible beep.
- **Camera** - Select a **Normal** or **Mirror** image for camera input.

Time

- **Time** - Press the current time to edit, then use the up and down arrows to change the hour and minute settings.
- **Year** - Press the current year to edit, then use the up and down arrows to increase or decrease the value.
- **Month** - Press the current month to edit, then use the up and down arrows to increase or decrease the value.
- **Day** - Press the current day to edit, then use the up and down arrows to increase or decrease the value.

Language

- **Language** - Select desired language (this option is available only on certain models).

Audio

- **Subwoofer** - Turn the Subwoofer output **On** or **Off**.
- **Loudness** - Turn the Loudness function **On** or **Off**.
- **EQ** - Select from EQ options: **Pop**, **Rock**, **Classic**, **Jazz** or **Off**.

Video

- **Aspect Ratio** - Select one of the following ratios: **4:3LB**, **4:3PS** or **16:9**.
- **Brightness** - Adjust the brightness level from 0-14 (default is 7).
- **Contrast** - Adjust the contrast level from 0-14 (default is 7).
- **Saturation** - Adjust the saturation level from 0-14 (default is 7).
- **Hue** - Adjust the hue from 0-14 (default is 7).
- **Standard Video** - Press "Yes" to reset video adjustments to default values.

Tuner

- **Radio Region** - Set the unit for one of the following regions: **Europe**, **America 1**, **America 2**, **Japan** or **Russia**.

Calibration

- **Calibration** - Press **SELECT** to begin calibration of the touch screen. Press the center of the + as indicated on the screen to calibrate the touchscreen.

AM/FM Tuner Operation

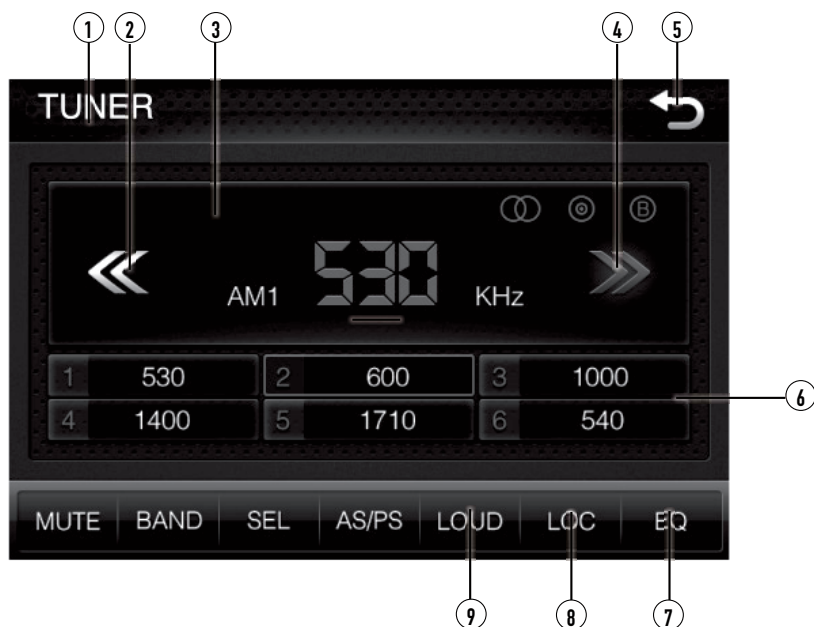

Tuner Operation

Select the Tuner icon from the Main Menu screen, press the **TUNER** button the front panel or press **MODE** until Tuner is selected.

Current Mode Indicator (1)

Displays current mode of operation.

Tune Frequency Down (2)

Press momentarily to manually tune to a lower frequency. Press and hold to seek tune to the previous strong station.

Information Display (3)

Displays information such as Loudness and EQ settings.

Tune Frequency Up (4)

Press momentarily to manually tune to a higher frequency. Press and hold to seek tune to the next strong station.

Main Menu Access (5)

Press to return to Main Menu screen.

Preset Station Display (6)

Displays the six preset stations stored in memory in the current band. Press any preset station to play it instantly. Up to 18 FM and 12 AM stations can be stored in memory.

EQ (7)

Press EQ to step through the following EQ options: **Pop, Rock, Classic, Jazz** or **Off**.

Local (8)

Press **LOC** to select between Local (**LOC ON**) and Distance (**LOC OFF**) tuning options. The local option tunes to nearby radio stations with sufficiently strong signals for good reception. In areas where reception is poor, switching to distance tuning enables the unit to tune in to more distant stations. Distance tuning is the default tuning mode.

Loudness (9)

Press **LOUD** to turn the Loudness feature **On** or **Off**.

AM/FM Tuner Operation

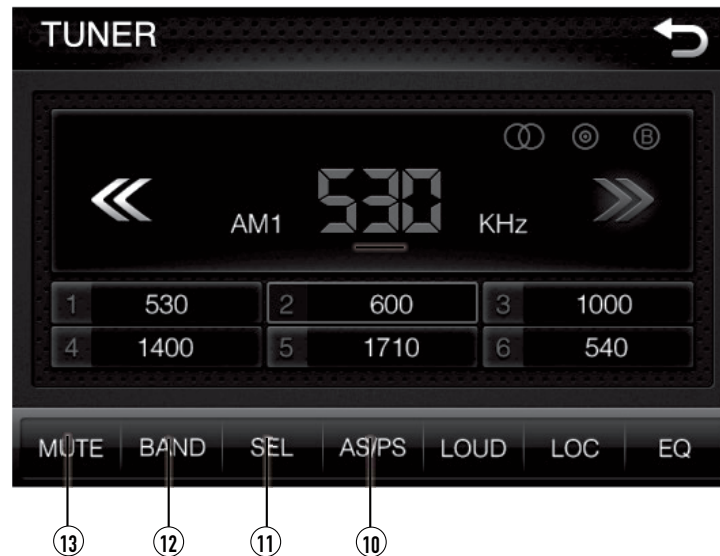

**Automatically Store /
Preset Scan** ⑩

Press and hold **AS/PS** to automatically find and store the strongest stations as presets. Press **AS/PS** momentarily to scan preset stations and play 10 seconds of each.

Note: To manually save preset stations, tune to the desired station, then press and hold the desired preset number in the preset station display. The stored preset station will appear next to the preset number when saved.

Press **SEL** to access Audio and Video setup menus.

Select ⑪

Audio Setup

- Volume - Adjust volume level from 0-39.
- Bass - Adjust bass level from -7 to 7.
- Treble - Adjust treble level from -7 to 7.
- Balance - Adjust balance from Left (L07) to Right (R07); "00" represents equal balance.
- Fader - Adjust fader from Front (F07) to Rear (R07); "00" represents equal fader.

Video Setup

- Brightness - Adjust brightness level from 0-14 (7 is the default).
- Contrast - Adjust contrast level from 0-14 (7 is the default).
- Saturation - Adjust saturation level from 0-14 (7 is the default).
- Hue - Adjust hue from 0-14 (7 is the default).

Band ⑫

Press **BAND** to toggle between AM and FM frequency bands.

Mute ⑬

Press **MUTE** to silence the radio. Press **MUTE** again to return to listening at the previously-selected volume.

CD Operation

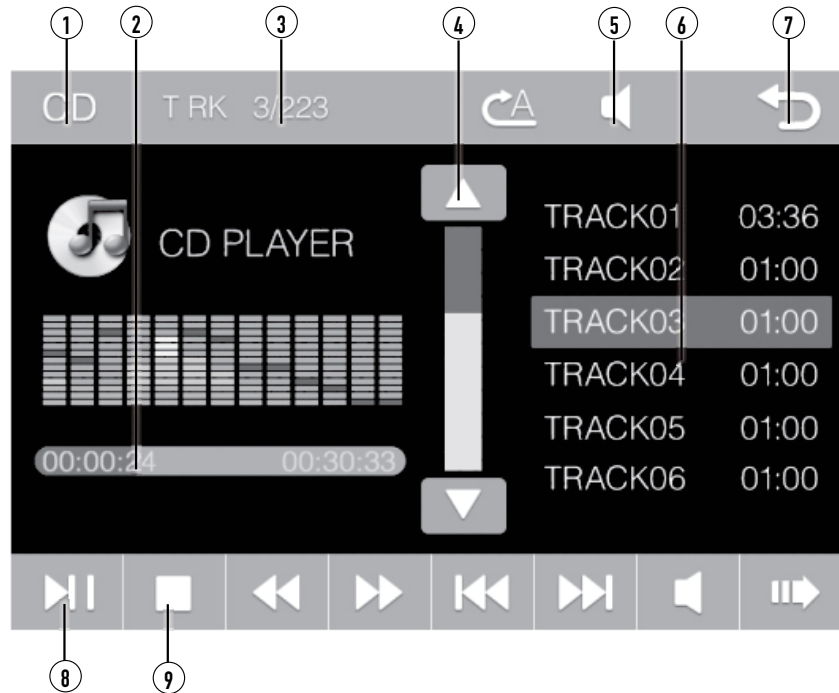

CD Operation

Insert disc into the slot with the label facing up at a slight upward angle, and playback will begin automatically. If a disc has previously been inserted and the unit has been operating in another mode, resume disc playback by selecting the DISC icon from the Main Menu screen, pressing **DVD** on the front panel or pressing **MODE** until DISC is selected.

- Current Mode Indicator** ① Displays current mode of operation.
- Elapsed Time Indicator** ② Displays the elapsed time of the current track.
- Track Indicator** ③ Displays the current and total number of tracks on the disc.
- Scroll Up / Down Arrows** ④ Press to scroll up or down the pages in the track playlist.
- Volume Indicator** ⑤ Displays the current volume setting of the unit.
- CD Track List** ⑥ Displays the first five tracks on the CD. Use the arrow keys to scroll down and up through the entire list, or press any track number to play it instantly. Elapsed time of current track will be displayed when playback begins.
- Main Menu Access** ⑦ Press to return to Main Menu screen.
- Play / Pause** ⑧ Press to pause CD. Press again to resume CD playback.
- Stop** ⑨ Press ■ to temporarily stop playback. Press play to resume playback from the current position. Press ■ a second time to fully stop playback. Press play to begin playback from the beginning of the disc.

CD Operation

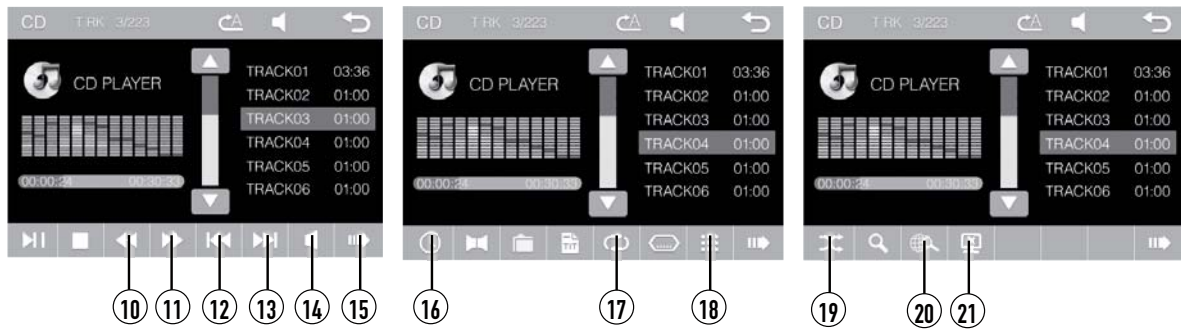

- | | |
|--|--|
| <p>Fast Reverse ⑩</p> <p>Fast Forward ⑪</p> <p>Previous Track ⑫</p> <p>Next Track ⑬</p> <p>Volume / Audio Settings ⑭</p> <p>Additional Options ⑮</p> <p>Time Indicator ⑯</p> <p>Repeat ⑰</p> <p>Direct Track Access ⑱</p> <p>Random ⑲</p> <p>Intro ⑳</p> <p>TFT Screen ㉑</p> | <p>Press ◀ to fast reverse CD playback. Each touch changes speed from 2x to 4x to 8x to 16x to 20x then back to regular playback.</p> <p>Press ▶ to fast forward CD playback. Each touch changes speed from 2x to 4x to 8x to 16x to 20x then back to regular playback.</p> <p>Press to go back to the previous track.</p> <p>Press to advance to the next track.</p> <p>Press to display and adjust the current volume level from 0 to 39. Touch VOL to step through the following audio settings:</p> <ul style="list-style-type: none"> • Bass- Adjust bass level from -7 to 7. • Treble - Adjust treble level from -7 to 7. • Balance - Adjust balance from Left (L07) to Right (R07); "00" represents equal balance. • Fader - Adjust fader from Front (F07) to Rear (R07); "00" represents equal fader. <p>Press to access additional CD playback options.</p> <p>Press to toggle from displaying the elapsed time to displaying the remaining time of the current track.</p> <p>Press to step through the Repeat options: RPT ONE (repeats current song), RPT ALL (repeats all songs on disc) and OFF.</p> <p>Press to access numeric keyboard to select desired track number. Input track number, press OK and playback of selected track will begin.</p> <p>Press to turn Random play ON or OFF.</p> <p>Press to play the first 10 seconds of each song on the disc. Press again to return to sequential play.</p> <p>Press to turn off the TFT display. Press anywhere on the touch screen to turn the display back on.</p> |
|--|--|

MP3/WMA/JPG Operation

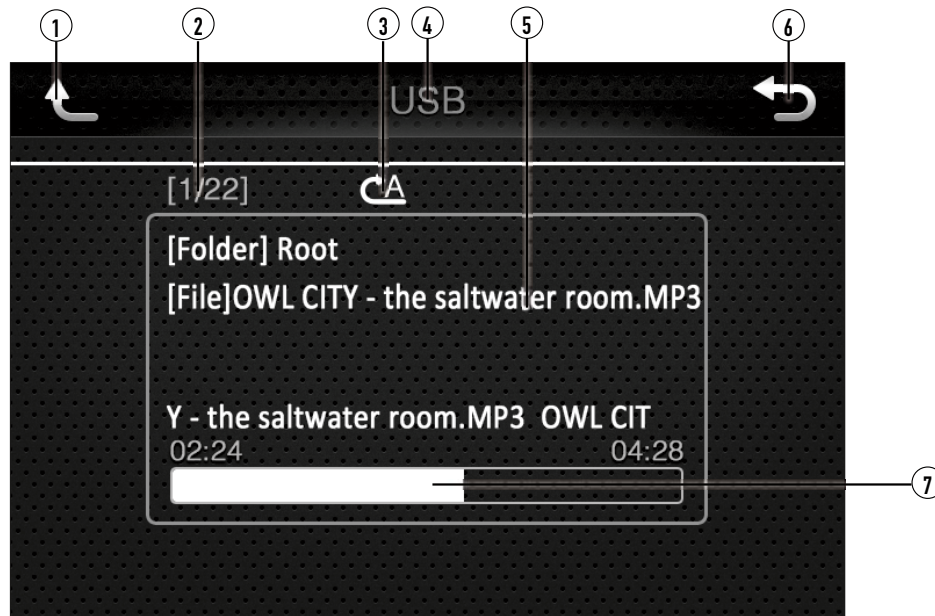

MP3/WMA/JPG Playback from Disc, USB Device or microSD Card

To play MP3, WMA and JPG files from a disc, USB device or micro SD card. Insert disc, connect USB device or insert microSD card, and playback will begin automatically. To return to disc, USB or microSD card playback from another mode of operation, select the DISC, USB or SD icon from the Main Menu screen or top icon display, or press **MODE** until DISC, USB or SD is selected.

- **Using a Cable** - Connect a USB device to the black USB input cable.
- **Using an SD Card** - Insert microSD card into the microSD slot on the front of the unit. When inserting a microSD card, the label faces up.

Note: It is not possible to view JPG files on the in-dash monitor while the vehicle is moving. This is a safety feature to prevent driver distraction. The JPG image viewer function will only operate when vehicle is in Park and the parking brake is engaged as described on page 22.

Navigation Button ①

Each press of this button navigates up through the following menus and folders: Folder Menu (list of all songs in folder), Device Menu (list of all folders) and Playback Menu (select between Music or JPG).

File Indicator ②

Indicates current file and the total number of files in the current folder.

OSD Controls ③

Press to view the OSD controls.

Current Mode Indicator ④

Displays current mode of operation.

Information Display ⑤

Scrolls through available file information, including file name, song title, artist name and album name.

Main Menu Access ⑥

Press to return to Main Menu screen.

Elapsed Time ⑦

Displays the elapsed time of the current track.

MP3/WMA/JPG Operation

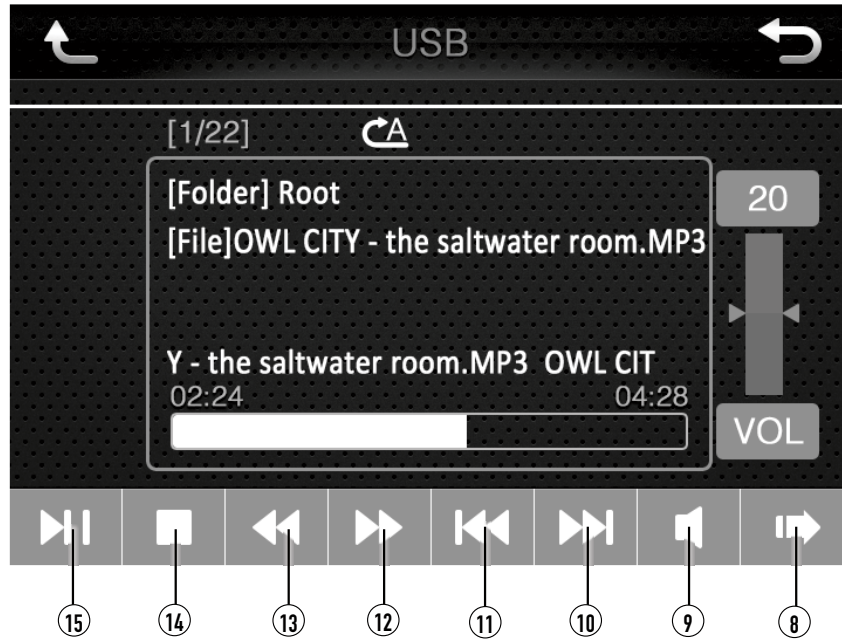

- | | |
|--|---|
| <p>Additional Options ⑧</p> <p>Volume / Audio Settings ⑨</p>
<p>Next File ⑩</p> <p>Previous File ⑪</p> <p>Fast Forward ⑫</p> <p>Fast Reverse ⑬</p>
<p>Stop ⑭</p> <p>Play / Pause ⑮</p> | <p>Press to access additional playback options.</p> <p>Press to display and adjust the current volume level from 0 to 39. Touch VOL to step through the following audio settings:</p> <ul style="list-style-type: none"> • Bass- Adjust bass level from -7 to 7. • Treble - Adjust treble level from -7 to 7. • Balance - Adjust balance from Left (L07) to Right (R07); "00" represents equal balance. • Fader - Adjust fader from Front (F07) to Rear (R07); "00" represents equal fader. <p>Press to advance to the next file.</p> <p>Press to go back to the previous file.</p> <p>Press ►► to fast forward file playback. Each touch changes speed from 2x to 4x to 8x to 16x to 20x then back to regular playback.</p> <p>Press ◀◀ to fast reverse file playback. Each touch changes speed from 2x to 4x to 8x to 16x to 20x then back to regular playback.</p> <p>Press ■ to temporarily stop playback and return to the current folder menu.</p> <p>Press to pause playback. Press again to resume playback.</p> |
|--|---|

MP3/WMA/JPG Operation

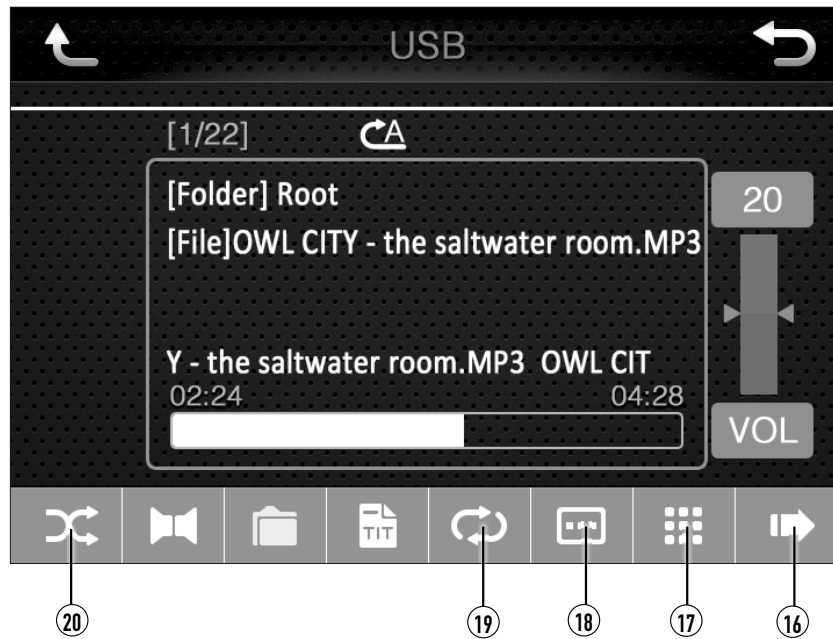

- Additional Options** ⑩ Press to return to original OSD option display.
- Direct Song Access** ⑪ Press to access numeric keyboard to select desired song number. Input song number, press **OK** and playback of selected song will begin.
- TFT Screen** ⑫ Press to turn off the TFT display. Press anywhere on the touch screen to turn the display back on.
- Repeat** ⑬ Press to step through the Repeat options: **RPT ONE** (repeats current song), **RPT Folder** (repeats all songs in current folder), **RPT ALL** (repeats all songs on device) and **OFF**.
- Random** ⑭ Press to turn the Random function ON or OFF.

MP3/WMA/JPG Operation

Viewing JPEG Images

When viewing JPG images, press **Area E** to display on-screen JPG controls.

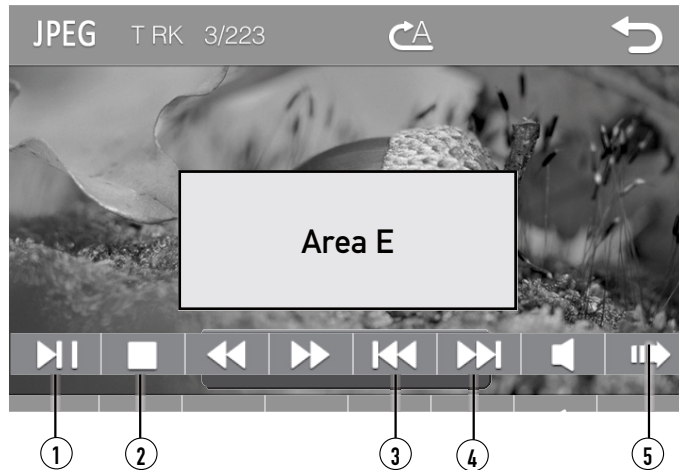

- Play / Pause** ①
- Stop** ②
- Previous Photo** ③
- Next Photo** ④
- Additional Options** ⑤

- Press to pause slideshow at current image. Press again to resume.
- Press to stop slideshow and return to photo menu.
- Press to go back to the previous image.
- Press to advance to the next image.
- Press to access additional photo options.

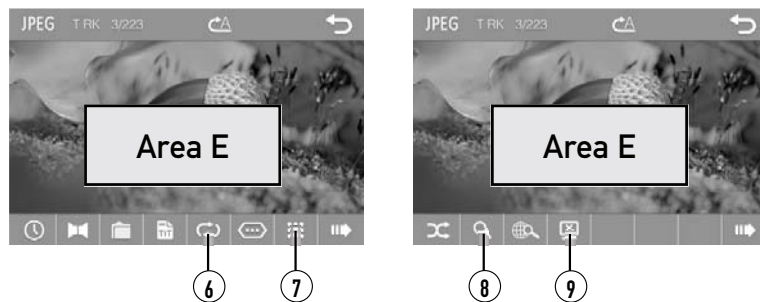

- Repeat** ⑥
- Direct File Access** ⑦
- Zoom** ⑧
- TFT Display** ⑨

- Press to step through the Repeat options: **RPT ONE** (repeats current image), **RPT FOLDER** (repeats all images in the current folder), **RPT ALL** (repeats all images on the disc or device) and **OFF**.
- Press to access numeric keyboard. Input file number, press **OK** and playback of selected file in the current folder will begin.
- Press to zoom in (2x, 3x, 4x) or out (1/2x, 1/3x, 1/4x) on the selected image or turn the zoom feature off.
- Press to turn off the TFT display. Press anywhere on the touch screen to turn the display back on.



Media Compatibility - USB/SD Card

File Type			WMA	MP3	
File System	FAT	FAT 12	X	X	
		FAT 16/FAT 32	✓	✓	
File Extension	.mp3/.MP3/.Mp3/.mP3		X	✓	
	.wma/.WMA		✓	X	
	.rmp/.m4a		X	X	
MPEG Format	MPEG 1		X	✓	
	MPEG 2		X	✓	
	MPEG 2.5		X	✓	
Sampling Frequency	MPEG 1		X	32/44.1/48kHz	
	MPEG 2		X	12/16/22.05/24kHz	
	MPEG 2.5		X	8/11.025/12kHz	
	WMA		32/44.1/48kHz	X	
Bitrate	MPEG 1		X	32 ~ 320kbps	
	MPEG 2		X	8 ~ 160kbps	
	MPEG 2.5		X	8 ~ 160kbps	
	WMA		32 ~ 192kbps	X	
Other Information	Directory Depth		Unlimited	Unlimited	
	File Name Length		32 bytes	32 bytes	
	Total File Number		2000 files	2000 files	
	Total Folder Number		200 folders	200 folders	
	File Number via Folder		2000 files	2000 files	
	MP3 ID3 TAG	ver.1.x		X	✓
		ver.2.x		X	✓
		Title, Artist, Album		X	✓
	WMA TAG	Title, Artist		✓	X

Notes:

- Due to ongoing technological advancement, some USB flash drives and/or SD cards may be incompatible with this unit.



Media Compatibility - CD/DVD

File Type			WMA	MP3	
File System	ISO9660	Level 1, Level 2	✓	✓	
		Level 3	X	X	
	ISO9660 Extension	JOLIET	Playback	✓	✓
			Filename	32 bytes	32 bytes
	Other Extensions	ROMEIO	Playback	X	X
			Filename	X	X
Apple ISO		X	X		
File Extension	.mp3/.MP3/.Mp3/.mP3		X	✓	
	.wma/.WMA		✓	X	
	.rmp/.m4a		X	X	
MPEG Format	MPEG 1		X	✓	
	MPEG 2		X	✓	
	MPEG 2.5		X	✓	
Sampling Frequency	MPEG 1		X	32/44.1/48kHz	
	MPEG 2		X	12/16/22.05/24kHz	
	MPEG 2.5		X	8/11.025/12kHz	
	WMA		32/44.1/48kHz	X	
Bitrate	MPEG 1		X	32 ~ 320kbps	
	MPEG 2		X	8 ~ 160kbps	
	MPEG 2.5		X	8 ~ 160kbps	
	WMA		32 ~ 192kbps	X	
Other Information	Directory Depth		Unlimited	Unlimited	
	File Name Length		32 bytes	32 bytes	
	Total File Number		2000 files	2000 files	
	Total Folder Number		200 folders	200 folders	
	File Number via Folder		2000 files	2000 files	
	MP3 ID3 TAG	ver.1.x		X	✓
		ver.2.x		X	✓
		Title, Artist, Album		X	✓
WMA TAG	Title, Artist		✓	X	



Media Compatibility

Media Compatibility	<p>The following types of discs are compatible:</p> <ul style="list-style-type: none">• CD-DA, CD-ROM (ISO), CD-R, CD-RW• DVD Video, DVD+R/RW, DVD-R/RW <p>The following types of discs/files are not compatible:</p> <ul style="list-style-type: none">• WMA files that are protected by DRM (Digital Rights Management)• WMA lossless format• Discs recorded with Track At Once or packet writing• MP3 PRO format, MP3 playlists• RMP format• WAV format• WMV format• DivX, Xvid format• AVI format• MPG, MPEG-4 format• AAC, protected AAC, M4A format <p>Some recordable DVD's and CD's may be incompatible with this unit, depending on media type and recording method.</p>
Playback Order	<p>MP3/WMA playback sequence begins in the root folder of the disc, USB flash drive or SD card. Any empty folders or folders that do not include MP3/WMA/JPG files are skipped.</p>
Compatible Recording Formats	<p>ISO9660 standards:</p> <ul style="list-style-type: none">• Maximum nested folder depth is 8 (including the root folder).• Valid characters for folder/file names are letters A-Z (all caps), numbers 0-9, and “_” (underscore). Some characters may not be displayed correctly, depending on the character type.• This device can play back discs in Joliet and other standards that conform to ISO9660. MP3/WMA written in the formats other than the above may not play and/or their file names or folder names may not be displayed properly.
Additional MP3/WMA Information	<p>An internal buffer provides ESP (Electronic Skip Protection) to virtually eliminate skipping.</p> <p>When playing a disc recorded with regular audio files (CD-DA or .WAV) and MP3/WMA files, the unit will play the MP3/WMA files only.</p>
Notes	<p>Some files may not play or be displayed correctly, depending on sampling rates and bit rates.</p> <p>For best results, use the following settings when ripping MP3 files: 128kbps or higher constant bit rate 44.1kHz or higher sampling frequency</p> <p>For best results, use the following settings when ripping WMA files: 64kbps or higher constant bit rate 44.1kHz or higher sampling frequency</p>



⚠ WARNING ⚠

Upon installation of this Monitor/DVD player ("unit") into a vehicle, the driver of the vehicle must not operate this unit by watching videos or playing video games while driving. Failure to follow this instruction could lead to driver distraction which could result in serious injury or death to the vehicle's occupants or persons outside the vehicle and/or property damage.

Several states prohibit the installation of monitors/DVD players if the screen is visible from the driver's seat. If you reside in a jurisdiction which has enacted such a law, this unit must not be installed so that the screen is visible from the driver's seat. When installing this unit in the front console/dashboard, the unit must be positioned so that it is facing the front passenger seat only. Failure to follow this instruction could lead to driver distraction which could result in serious injury or death to the vehicle's occupants or persons outside the vehicle and/or property damage.

This unit is designed so that it may be operated only when the vehicle is in "Park" and the parking brake is fully engaged. To this end, this unit includes a parking brake lock-out feature which prohibits the unit from operating if the vehicle is not in "Park" and/or the parking brake is not fully engaged. When installing this unit, the installer must connect the parking brake detect wire ("Pink Lead") to the parking brake mechanism in order to make the parking brake lock-out feature operable. DO NOT simply ground the parking brake detect wire to a metal portion of the vehicle. Failure to properly install the parking brake lock-out feature could lead to driver distraction which could result in serious injury or death to the driver's occupants or persons outside the vehicle and/or property damage.

Once the parking brake lock-out feature is installed, the owner/user must not attempt to disrupt/neutralize the parking brake lock-out feature by (a) partially engaging the parking brake and/or (b) purchasing/using any device or unit designed to send necessary brake signals to the unit. Failure to follow these instructions could lead to driver distraction which could result in serious injury or death to the driver's occupants or persons outside the vehicle and/or property damage.

When operating this unit, keep the unit's volume level low enough so that the vehicle's occupants can hear traffic-related sounds such as police and emergency vehicles. Failure to follow this instruction could lead to driver distraction which could result in serious injury or death to the vehicle's occupants or persons outside the vehicle and/or property damage.



DVD Setup - Region Management

DVD Region Management

Some DVD discs can be played only in certain playback modes according to the intentions of the software. As the DSA2062 plays discs according to their intentions, some functions may not work as intended. Please be sure to read the instructions provided with each disc. This player has been designed to play back DVD software that has been encoded for specific region areas. It cannot play back DVD software encoded for other region areas than the region areas for which it has been designed.

The DSA2062 will play discs labeled "Region 1" or "All".

DVD region codes:

- 1 - USA, Canada
- 2 - Japan, Europe, South Africa, Middle East
- 3 - Rep. of Korea, Taiwan, Hong Kong, Parts of Southeast Asia
- 4 - Australia, New Zealand, Mexico, South America
- 5 - Eastern Europe, Russia, India, Africa
- 6 - China



DVD Disc Symbols

Symbol	12cm Disc Properties	Max Play Time
	Single side single layer (DVD-5) Single side double layer (DVD-9) Double side single layer (DVD-10) Double side double layer (DVD-18)	(MPEG 2 Method) 133 minutes 242 minutes 266 minutes 484 minutes
	Single side single layer (VCD)	(MPEG 1 Method) 74 minutes
	Single side single layer	74 minutes

Symbol	Meaning
	Number of voice languages recorded. The number inside the icon indicates the number languages on the disc (maximum of 8).
	Number of subtitle languages available on the disc (maximum of 32).
	Number of angles provided (maximum of 9).
	Aspect ratios available. "LB" stands for Letter Box and "PS" stands for Pan/Scan. In the example on the left, the 16:9 video can be converted to Letter Box video.
	Indicates the region code where the disc can be played. <ul style="list-style-type: none"> • Region 1: USA, Canada, East Pacific Ocean Islands • Region 2: Japan, Western Europe, Northern Europe, Egypt, South Africa, Middle East • Region 3: Taiwan, Hong Kong, South Korea, Thailand, Indonesia, South-East Asia • Region 4: Australia, New Zealand, Middle and South America, South Pacific Ocean Islands/ Oceania • Region 5: Russia, Mongolia, India, Middle Asia, Eastern Europe, North Korea, North Africa, North-West Asia

Notes:

Some DVD discs can be played only in certain playback modes according to the intentions of the software. As the DSA2062 plays discs according to their intentions, some functions may not work as intended. Please be sure to read the instructions provided with each disc.

DVD Setup - Parking Brake Initialization

SAFETY WARNING

- The video display of the in-dash unit will not operate while the vehicle is moving. This is a safety feature to prevent driver distraction. In-dash video functions will only operate when vehicle is in Park and the **PARKING BRAKE** is engaged. It is illegal in most states for the driver to view video while the vehicle is in motion. Refer to local laws in your area.
- The vehicle must be in park and the parking brake applied to view video on the in-dash monitor.
- As a safety feature, a warning message will show on the display when the vehicle's parking brake is not engaged. Video display on the in-dash monitor isn't allowed until the **PARKING BRAKE** is engaged. Connect the pink **PARKING BRAKE** wire to the brake switch circuit as described on page 6. **Note:** DVD and AUX AV audio can be heard while the vehicle is in motion without engaging the parking brake.

Parking Brake Initialization

- 1) Come to a complete stop, and put the vehicle in Park.
- 2) Fully engage parking brake.

DVD Operation



Inserting a Disc

Insert disc into the slot at a slight upward angle and playback will begin automatically. Sub-menus may have to be pressed to access the DVD content. Read the directions of your specific DVD disc for other features.

Ejecting the Disc

Press to eject the disc.

Current Mode Indicator ①

Displays current mode of operation.

Current Chapter Indicator ②

Indicates the current chapter and total number of chapters on the DVD. Press to access numeric keyboard to select desired chapter number. Input chapter number, press **OK** and playback of selected chapter will begin.

Main Menu Access ③

Press to return to main menu screen.

Touchscreen Controls ④

During DVD playback, press **Area E** to display on-screen DVD controls.

Additional Options ⑤

Press to access additional DVD options.

Volume / Audio Settings ⑥

Press to display and adjust the current volume level from 0 to 39. Touch **VOL** to step through the following audio settings:

- Bass- Adjust bass level from -7 to 7.
- Treble - Adjust treble level from -7 to 7.
- Balance - Adjust balance from Left (L07) to Right (R07); "00" represents equal balance.
- Fader - Adjust fader from Front (F07) to Rear (R07); "00" represents equal fader.

DVD Operation

- Next Chapter** ⑦ Press to advance to the next chapter.
- Previous Chapter** ⑧ Press to go back to the previous chapter.
- Fast Forward** ⑨ Press ►► to fast forward DVD playback. Each touch changes speed from 2x to 4x to 8x to 16x to 20x then back to regular playback.
- Fast Reverse** ⑩ Press ◀◀ to fast reverse DVD playback. Each touch changes speed from 2x to 4x to 8x to 16x to 20x then back to regular playback.
- Stop** ⑪ Press ■ to temporarily stop playback. Press play to resume playback from the current position. Press ■ a second time to fully stop playback. Press play to begin playback from the beginning of the DVD.
- Play / Pause** ⑫ Press to pause playback. Press again to resume playback.
- Elapsed Time Indicator** ⑬ Shows the elapsed time of DVD playback.

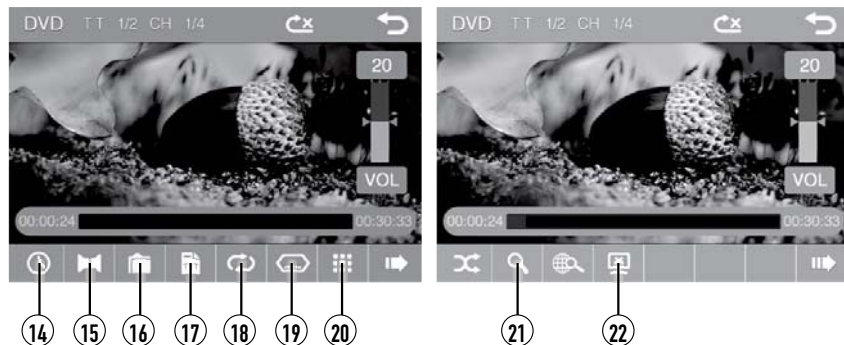

- Remaining Time** ⑭ Press to view the remaining time rather than the elapsed time (default).
- Language Options** ⑮ Press to select different language options (if available).
- Previous Folder** ⑯ Press to return to the previous folder on the DVD (if available).
- Title Menu** ⑰ Press to return to the title menu of the DVD.
- Repeat** ⑱ Press to step through the Repeat options: **CHAPTER**, **TITLE**, **RPT ALL** and **OFF**.
- Subtitle Language** ⑲ Press to select desired subtitle language (if available): English, Spanish, French or Off.
- Direct Chapter Access** ⑳ Press to access numeric keyboard to select desired chapter number. Input chapter number, press **OK** and playback of selected chapter will begin.
- Zoom** ㉑ Press to zoom in (2x, 3x, 4x) or out (1/2x, 1/3x, 1/4x) during DVD playback or turn the zoom feature off.
- TFT Screen** ㉒ Press to turn off the TFT display. Press anywhere on the touch screen to turn the display back on.



Auxiliary Inputs - AV1 & AV2

Using AV1 Input

Connect an optional audio/video source into the 3.5mm (front panel) input.

Select AV1 from the Main Menu to listen to audio.

Engage parking brake as described on page 24 to watch video.

Adjust volume on the external audio source as needed (if connected to the headphone output of the device).

Using AV2 Input

Connect an optional audio/video source to the Auxiliary Input 2 (Red/White/Yellow RCA connectors). Refer to page 6 for details.

Select AV2 from the Main Menu to listen to audio.

Engage parking brake as described on page 24 to watch video.

Rear Camera Operation - (Optional)

Using Rear Camera

Connect an optional rear camera to the Camera Input (purple RCA connector). Refer to page 6 for details.

The unit will automatically select camera mode when connected to the reverse lamp circuitry. Refer to page 6 for details.



Limited One Year Warranty

This warranty gives you specific legal rights. You may also have other rights which vary from state to state.

Dual Electronics Corp. warrants this product to the original purchaser to be free from defects in material and workmanship for a period of one year from the date of the original purchase.

Dual Electronics Corp. agrees, at our option, during the warranty period, to repair any defect in material or workmanship or to furnish an equal new, renewed or comparable product (whichever is deemed necessary) in exchange without charges, subject to verification of the defect or malfunction and proof of the date of purchase. Subsequent replacement products are warranted for the balance of the original warranty period.

Who is covered? This warranty is extended to the original retail purchaser for products purchased from an authorized Dual dealer and used in the U.S.A.

What is covered? This warranty covers all defects in material and workmanship in this product. The following are not covered: software, installation/removal costs, damage resulting from accident, misuse, abuse, neglect, product modification, improper installation, incorrect line voltage, unauthorized repair or failure to follow instructions supplied with the product, or damage occurring during return shipment of the product. Specific license conditions and copyright notices for the software can be found via www.dualav.com.

What to do?

1. Before you call for service, check the troubleshooting guide in your owner's manual. A slight adjustment of any custom controls may save you a service call.
2. If you require service during the warranty period, you must carefully pack the product (preferably in the original package) and ship it by prepaid transportation with a copy of the original receipt from the retailer to an authorized service center.
3. Please describe your problem in writing and include your name, a return UPS shipping address (P.O. Box not acceptable), and a daytime phone number with your shipment.
4. For more information and for the location of the nearest authorized service center please contact us by one of the following methods:
 - Call us toll-free at 1-866-382-5476
 - E-mail us at cs@dualav.com

Exclusion of Certain Damages: This warranty is exclusive and in lieu of any and all other warranties, expressed or implied, including without limitation the implied warranties of merchantability and fitness for a particular purpose and any obligation, liability, right, claim or remedy in contract or tort, whether or not arising from the company's negligence, actual or imputed. No person or representative is authorized to assume for the company any other liability in connection with the sale of this product. In no event shall the company be liable for indirect, incidental or consequential damages.



DSA2062 OPERATION

Specifications

Disc	Frequency response: 20Hz-20kHz Channel separation @ 1kHz: >80dB D/A converter: 24 Bit
FM Tuner	Tuning range: 87.5MHz-107.9MHz Usable sensitivity: 10dBf 50dB quieting sensitivity: 20dBf Stereo separation @ 1kHz: 38dB Frequency response: 30Hz-13kHz
AM Tuner	Tuning range: 530kHz-1710kHz Usable sensitivity: 24uV Frequency response: 30Hz-2.3kHz
USB	Compatibility: High Speed USB 2.0 Output: 5VDC, 500mA USB Class: Mass storage class
SD	Compatibility: SD memory card & SDHC memory card
Monitor	Panel size: 6.2" diagonal measurement View angle (up/down/left/right): 70/70/75/75 Resolution: 800 (H) x 480 (V) Brightness (cd/m ²): 400 Contrast ratio: 600:1 Pixels: 1,152,000
General	Speaker output impedance: 4 ohms Line output voltage: 2 volts Line output impedance: 200 ohms Chassis dimensions: 7" x 7" x 4" (W x D x H)

Design and specifications subject to change without notice.



CEA-2006 Power Standard Specifications
(reference: 14.4VDC +/- 0.2V, 20Hz~20kHz)

Power Output: 18 Watts RMS x 4 channels at 4 ohms and \leq 1% THD+N
Signal to Noise Ratio: 80dBA (reference: 1 watt into 4 ohms)



Troubleshooting

General		
Problem	Cause	Action
Unit will not turn on (no power)	Yellow wire not connected or incorrect voltage Red wire not connected or incorrect voltage	Check connections for proper voltage (11~16VDC)
	Black wire not connected	Check connection to ground
	Fuse blown	Replace fuse(s)
	Speaker wires not connected	Check connections at speakers
Unit has power (but no sound)	One or more speaker wires touching each other or touching chassis ground	Insulate all bare speaker wires from each other and chassis ground
	Yellow or red wire touching chassis ground	Check for pinched wire
Unit blows fuse(s)	Speaker wires touching chassis ground	Check for pinched wire
	Incorrect fuse rating	Use fuses with correct rating
	Parking brake safety circuit not connected Parking brake not applied	Check connections at parking brake Apply parking brake as described on page 24
Unit has audio (but no video)	Reverse circuit not connected Vehicle is not in reverse	Check connections at reverse lamp Select reverse gear
No video display (when in reverse)	Physical defect in media Wrong region	Check media for scratches Use discs labeled "Region 1" or "All" only
DVD does not start playback	Physical defect in media Wrong region	Check media for scratches Use discs labeled "Region 1" or "All" only
IR remote does not work	Dead battery	Replace battery
Excessive skipping	Unit is not mounted correctly	Check mounting sleeve
	Physical defect in media	Check media for scratches
"Wrong Region" appears on display	Region code error	Use discs labeled "Region 1" or "All" only

For Your Records

Please keep your original sales receipt and be prepared to provide this receipt in the event you require service, as your original receipt is considered the best proof of purchase and indicates the date you purchased your Dual product.

Dealer Name _____

Dealer Phone _____

Purchase Date _____

Register Your Product

Register your product online at www.dualav.com



Notes





Dual Electronics Corp.
Toll Free: 1-866-382-5476

www.dualav.com
©2013 Dual Electronics Corp. All rights reserved.
NSA1112-V01
Printed in China